

## FELCO 51 - Green

- Hoof clippers

Made in Switzerland by FELCO



220mm/8.7in. 260g/9.2oz.



- > **Reliable:** comfortable, light, sturdy handles made of forged aluminium with a lifetime guarantee\* / blade and screw-mounted anvil blade made of high-quality hardened steel / clean, precise cut / all parts can be replaced
- > **Efficient:** easy, durable cutting adjustment / Protection against the risk of hoof infections thanks to blades coated with XYLAN®
- > **Ergonomic:** hand and wrist protection and optimisation of the force exerted are provided by the ideal shape of the handles, the angled head and the cushion-shock absorber / non-slip coating

## RECOMMENDED FOR

Our recommendation (★ = Recommended, ★★ = Strongly recommended, ★★★ = Best fit)

Ovine and caprine rearing	★★★
Small hand	★★★
Average-sized hand	★★★
Large hand	★★★
Right-handed	★★★
Left-handed	★★★

## CUTTING CAPACITIES

Material

Maximum cutting diameter

Sheep / goat hooves



## ACCESSORIES



FELCO 902  
Sharpening tool  
Sharpening stone



FELCO 903  
Sharpening tool  
Sharpener



FELCO 910  
Holster  
Leather - With belt loop and clip



FELCO 912  
Holster  
Leather - With belt clip



FELCO 980  
Maintenance product  
Spray







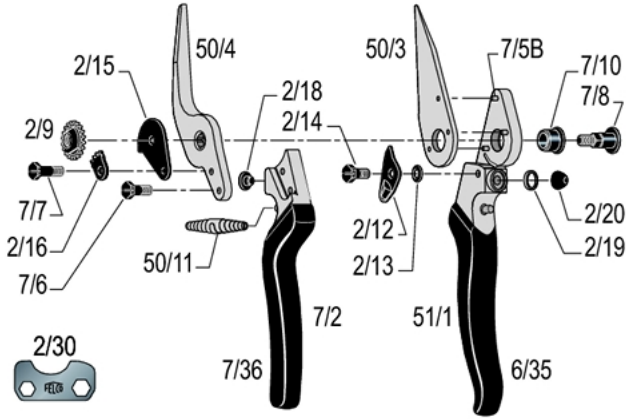





























FELCO 990  
Maintenance product  
Grease

**SPARE PARTS**



FELCO	REF.	Designation	Composition	UCC Barcode
	2/30	Adjustment key	1x 2/30	
	50/3	Blade	1x 50/3	
	50/4	Anvil-blade	1x 50/4	
	7/90	Kit	1x 7/7 + 1x 2/16 + 1x 2/9 + 1x 7/8	
	2/92	Kit	1x 2/15 + 1x 2/18 + 1x 2/14 + 1x 2/12 + 1x 2/13 + 1x 2/20	
	2/93	Kit	4x 2/18 + 6x 2/20	
	7/94	Kit	1x 2/9 + 1x 7/8	
	51/1	Handle without blade	1x 51/1 + 3x 7/5B + 1x 2/19 + 1x 2/20 + 1x 7/10 + 1x 2/13 + 1x 2/12 + 1x 2/14 + 1x 6/35	
	7/2	Handle without anvil-blade	1x 7/2 + 1x 2/18 + 1x 7/36	

	6/35	Coating for blade handle	1x 6/35	 7 83929 40219 2
	7/36	Coating for anvil-blade / anvil handle	1x 7/36	 7 83929 40239 0
	7/5B	Rivet for blade	1x 7/5B	 7 83929 40240 6
	7/6	Screw for anvil-blade	1x 7/6	 7 83929 40241 3
	7/8	Bolt	1x 7/8	 7 83929 40243 7
	2/9	Nut	1x 2/9	 7 83929 40169 0
	7/10	Bush	1x 7/10	 7 83929 40235 2
	50/11	White spring	1x 50/11	 7 83929 40214 7
	2/12	Thumb catch	1x 2/12	 7 83929 40153 9
	2/13	Spring for thumb catch	1x 2/13	 7 83929 40154 6
	2/14	Screw for thumb catch	1x 2/14	 7 83929 40155 3
	2/15	Catch plate	1x 2/15	 7 83929 40156 0
	2/16	Locking segment	1x 2/16	 7 83929 40157 7
	7/7	Screw for locking segment	1x 7/7	 7 83929 40242 0
	2/18	Cushion	1x 2/18	 7 83929 40159 1

	2/19	Edging	1x 2/19	 7 83929 40160 7
	2/20	Shock absorber	1x 2/20	 7 83929 40162 1

**MAINTENANCE**



**Cleaning**

It is advisable to clean your tool after each use.

If your tool is particularly dirty or subject to rusting after exposure to moisture, do not delay cleaning.



**Oiling**

After cleaning, it is advisable to oil the tool so as to protect it from corrosion. The oil will also unjam the tool.

## PARTS REPLACEMENT



### **Changing the shock absorber**

When the tool closes too abruptly during pruning, and the cushion is in good condition, the shock absorber should be changed.



### **Changing the cushion**

When the tool closes too abruptly during pruning and the shock absorber is in good condition, the cushion must be changed.



### **Changing the thumb catch**

When the thumb catch is damaged and loosens when used, even when the screw is readjusted, change it.



### **Changing the plastic coatings for handles**

If the coatings are badly damaged, you can replace them.

Soak the coatings for 2 minutes in boiling water - recommended glue: Loctite 415.