

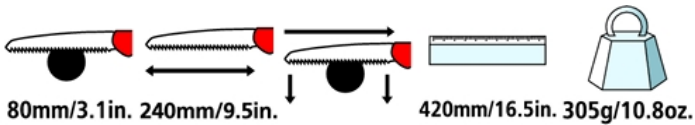

FELCO 621 - Green

Pull-stroke Pruning saw - Pull-stroke pruning saw - Blade 24 cm (9.5 in.)

Designed in Switzerland by FELCO, Made in South Korea, Guaranteed FELCO Quality, PATENT NO: US D500,656 S



- > **Reliable:** rust resistant chromed blade made of steel / impulse heat treatment of the teeth / clean, precise cut / parts can be replaced
- > **Efficient:** conical blade shape for an easy, non-clogging cut / the set and shape of the teeth prevents sap build-up / maintenance free
- > **Ergonomic:** comfortable non-slip handle / sheath for right- or left-handers with detachable belt loop



RECOMMENDED FOR

Our recommendation (★ = Recommended, ★★ = Strongly recommended, ★★★ = Best fit)

Viticulture	★ ★ ★
Arboriculture	★ ★ ★
Parks and Gardens	★ ★ ★
Small hand	★ ★ ★
Average-sized hand	★ ★ ★
Large hand	★ ★ ★
Right-handed	★ ★ ★
Left-handed	★ ★ ★



THE POINTS OF EXCELLENCE



Pull-stroke

The pull-stroke technique reduces effort and eliminates the risk of the blade pig-tailing.



Anticorrosion

Rust resistant chromed blade made of steel.



Cutting edge durability

Teeth are submitted to the impulse treatment in order to increase the durability of the saw's cutting edge.



Teeth geometry

The teeth geometry is particularly suited for cutting woodland. Improved clearance of metal shavings and a softer bite in order to avoid arm injuries/aches and pains.



Blade geometry

The shape of the long blade guarantees optimal comfortable working conditions and reduces vibrations.



Ergonomics

The ergonomic, non-slip handle provides good handling.



Sheath included

It is equipped with a detachable belt loop which allows you to wear the saw on the belt. Suited to both right-handers and left-handers.











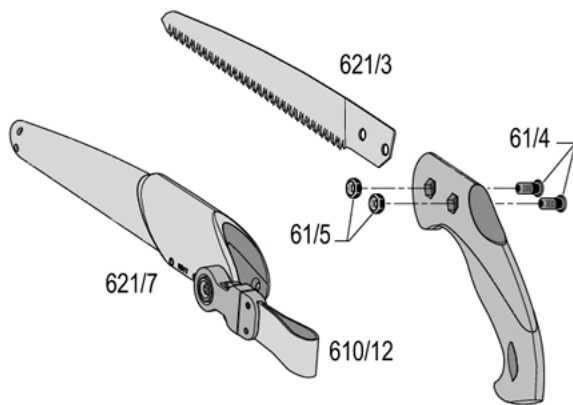

ACCESSORIES



FELCO 980
Maintenance product
Spray

SPARE PARTS



FELCO	REF.	Designation	Composition	UCC Barcode
	621/3	Blade	1x 621/3	 7 83929 40112 6
	61/4	Screw	1x 61/4	 7 83929 40227 7
	61/5	Nut	1x 61/5	 7 83929 40228 4
	610/12	Flange	1x 610/12	 7 83929 40229 1
	621/7	Holster	1x 621/7	 7 83929 40233 8



PARTS REPLACEMENT



Changing the blade

If the tool is no longer cutting properly, it is advisable to change it.